

Indicative Range; Custom Design Available

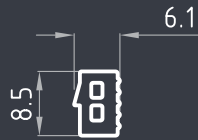

Part No. D03320

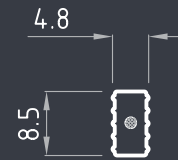

Part No. D03405

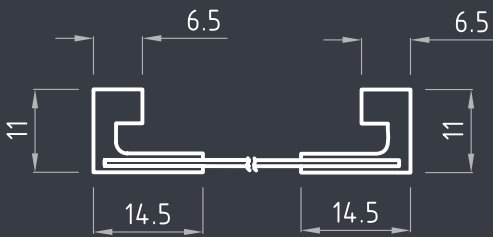

Part No. D00336
WITH FABRIC
INSERT

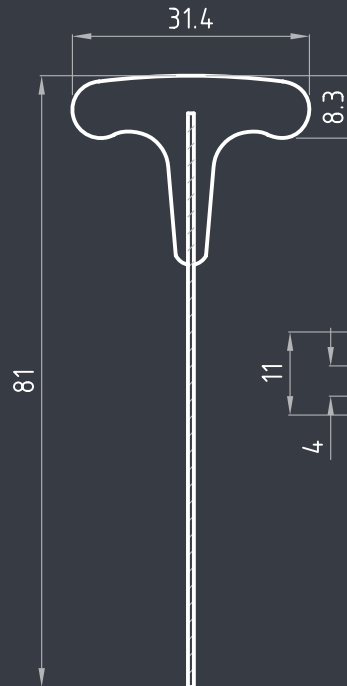

Part No. D02643
WITH FABRIC
INSERT

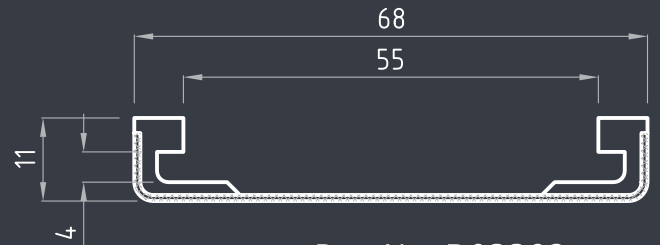

Part No. D03392
WITH FABRIC
INSERT

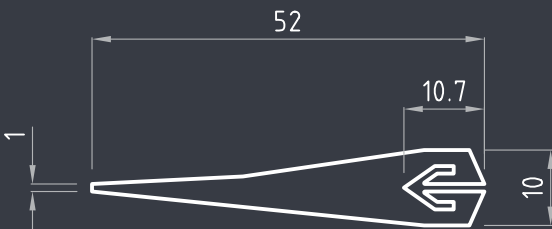

Part No. D02379

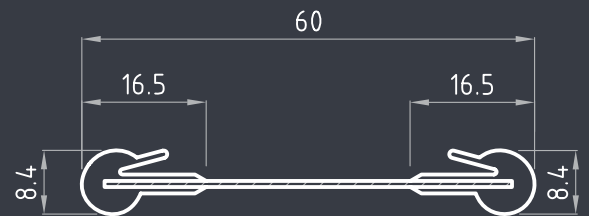

Part No. D02901
WITH FABRIC
INSERT

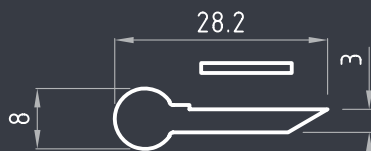

Part No. D02372
WITH HARD BACK
INSERT

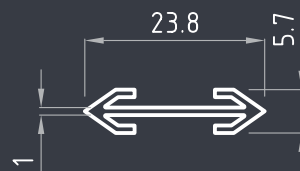

Part No. D02378

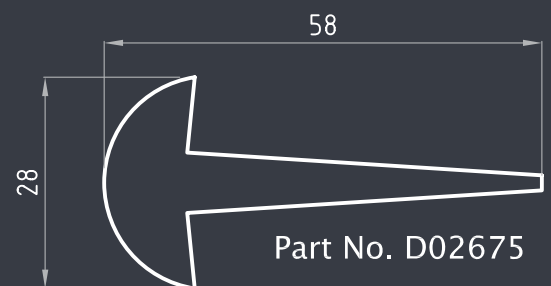

Part No. D02675

Indicative Range; Custom Design Available

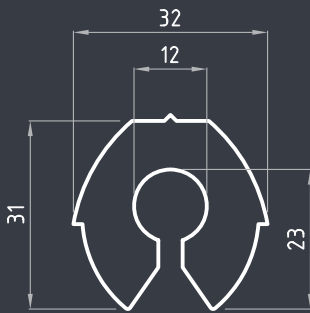

No. 13
Part No. D02155

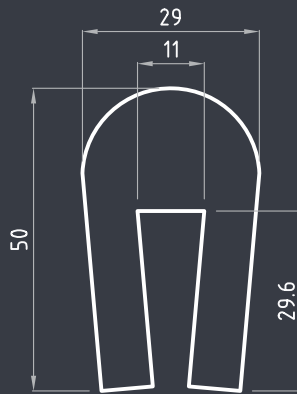

Part No. D02002

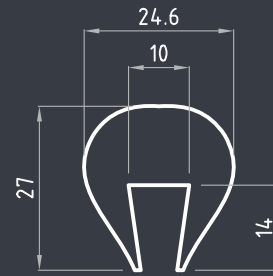

Part No. D02365

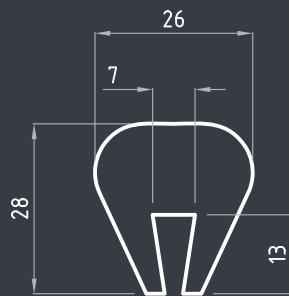

Part No. D01057

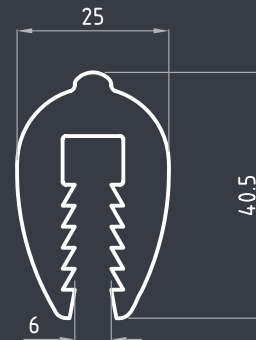

Part No. D03429

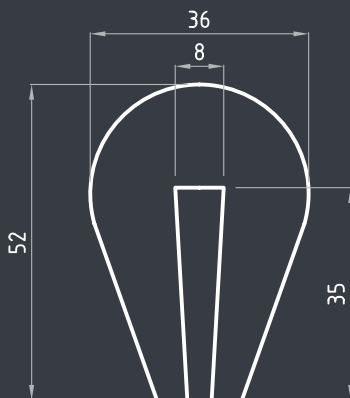

Part No. D02453

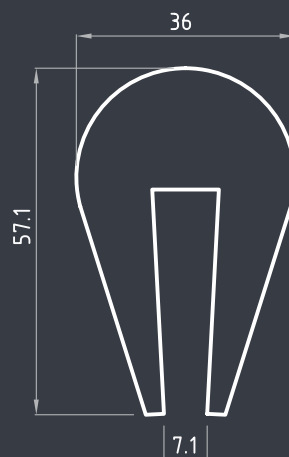

Part No. D03612

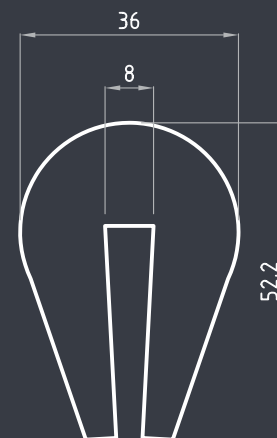

Part No. D00687

Indicative Range; Custom Design Available

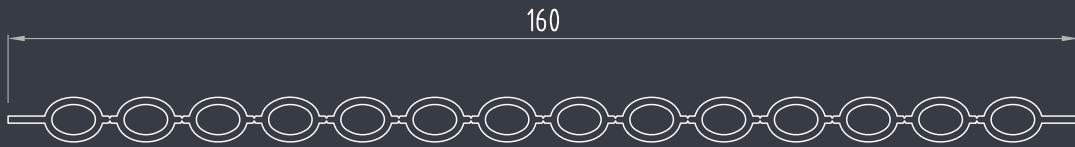

Part No. D02248

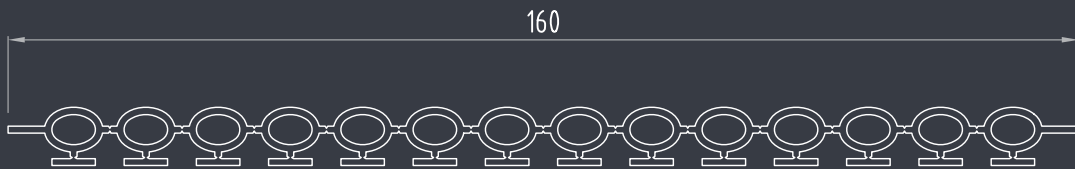

Part No. D02628

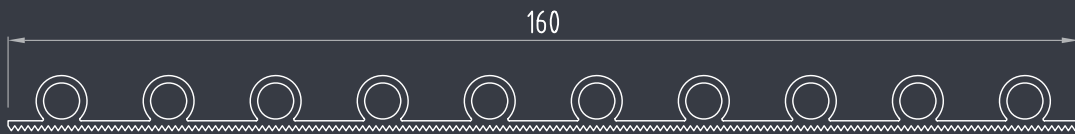

Part No. D02513

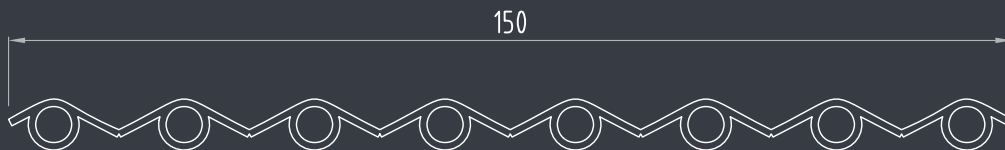

Part No. D02507

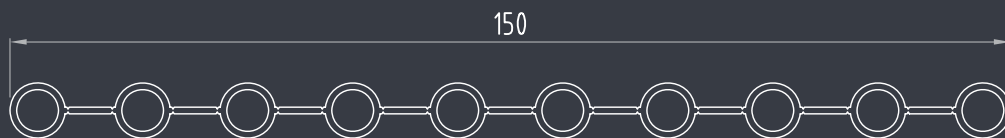

Part No. D02627

Indicative Range; Custom Design Available

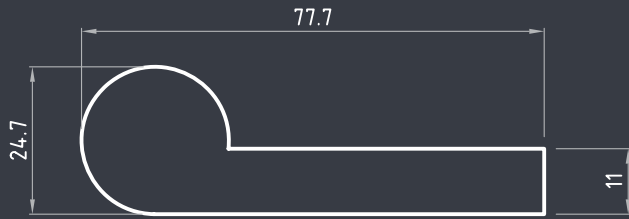

Part No. D00990

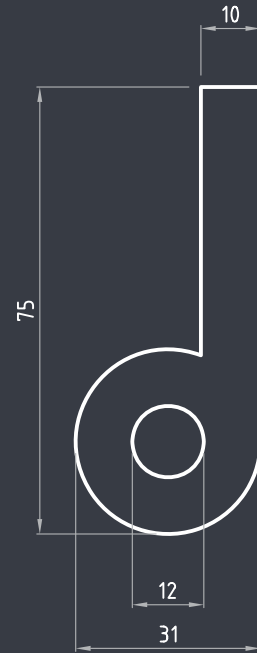

Part No. D02210

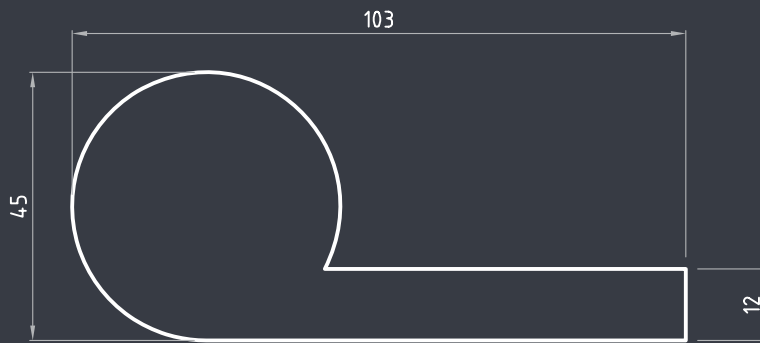

Part No. D00269



Part No. D02151

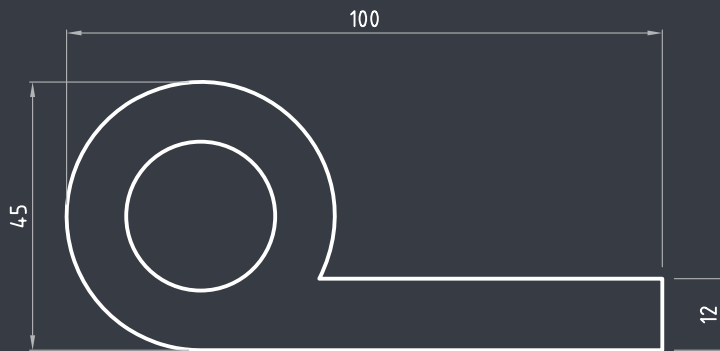

Part No. D00268

Indicative Range; Custom Design Available

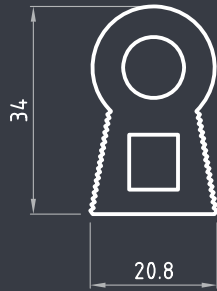

Part No. D02915

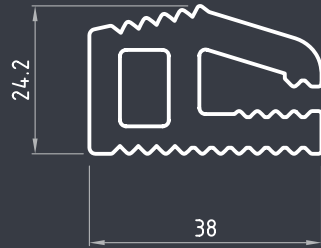

Part No. D03039



Part No. D03665

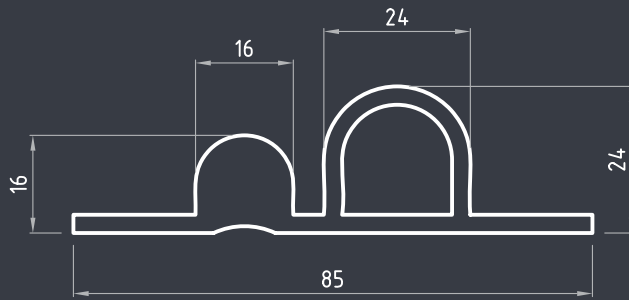

Part No. D03516

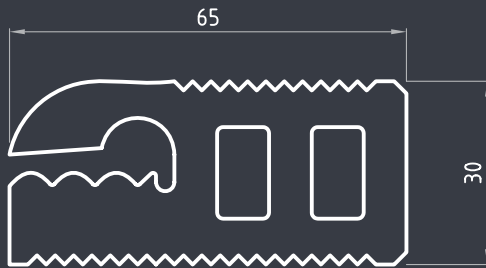

Part No. D02712



Part No. D02962

Indicative Range; Custom Design Available

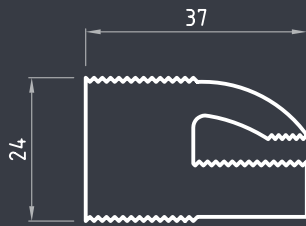

Part No. D02615

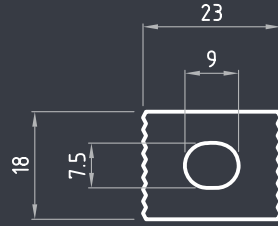

Part No. D02543

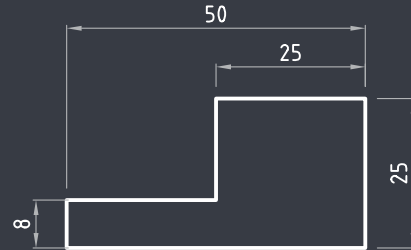

Part No. D02847

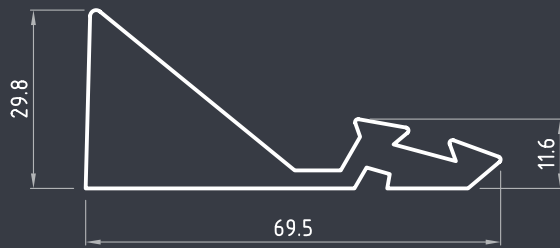

Part No. D02326

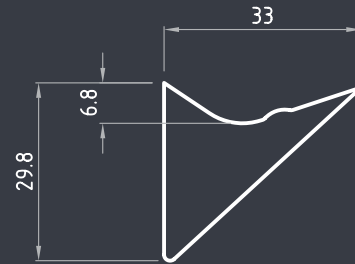

Part No. D02279



Part No. D01062

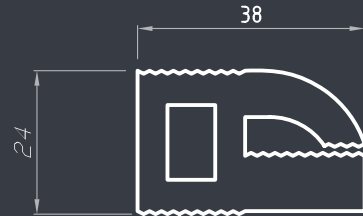

Part No. D02361

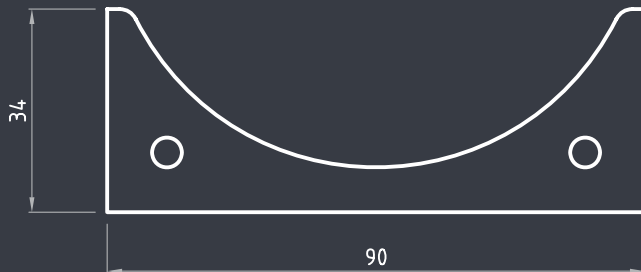

Part No. D03025

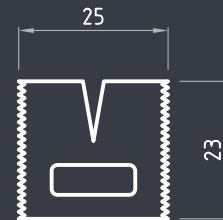

Part No. D03125

Indicative Range; Custom Design Available

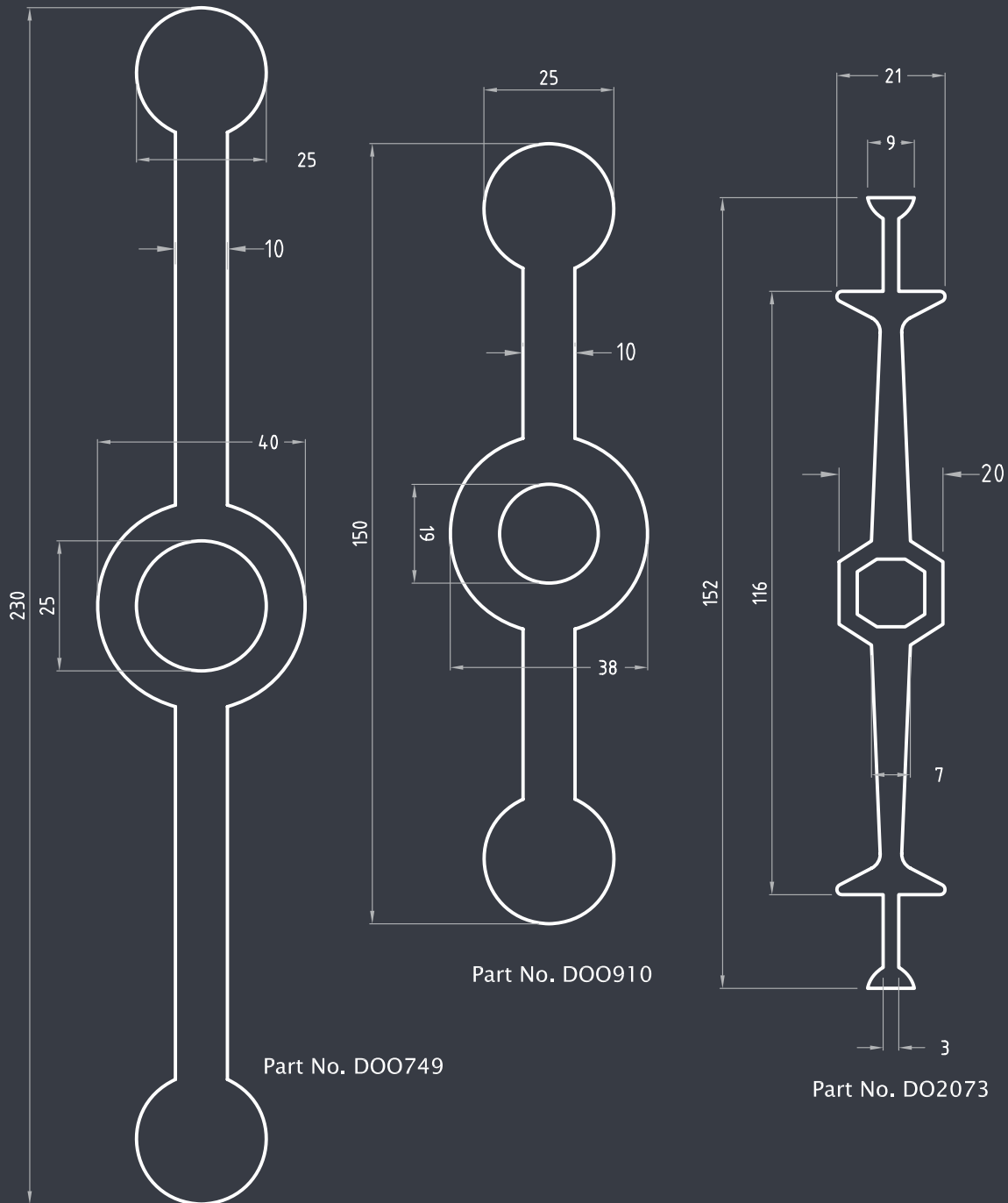

Indicative Range; Custom Design Available

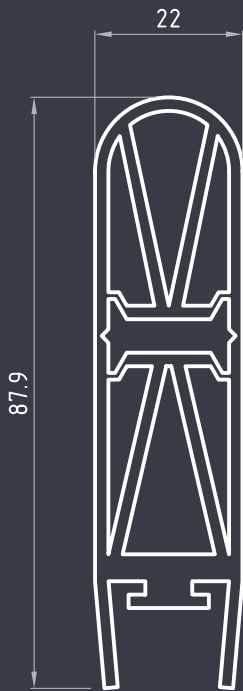

Part No. D02068

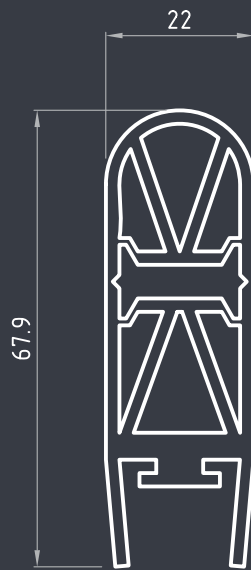

Part No. D02067

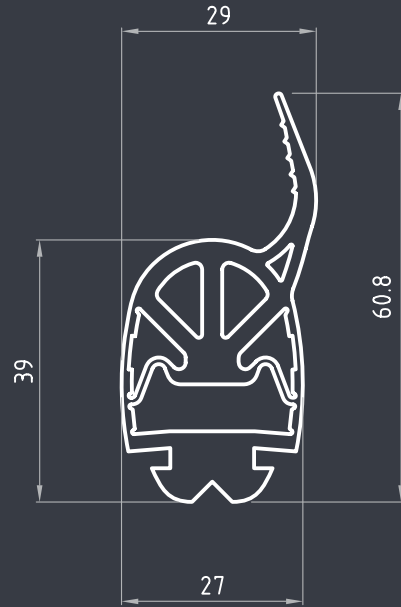

Part No. D02585

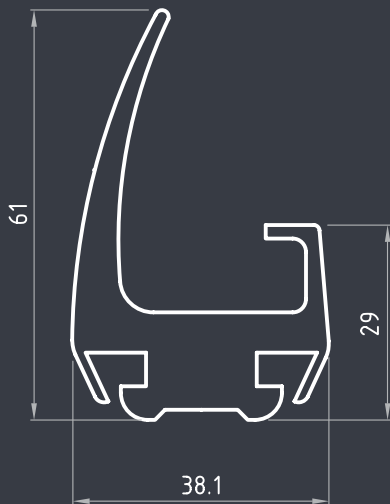

Part No. D02516

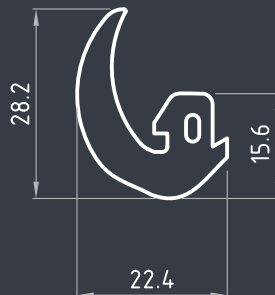

Part No. D02517

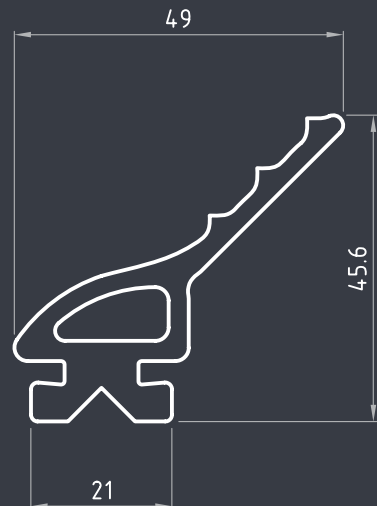

Part No. D02515

Indicative Range; Custom Design Available

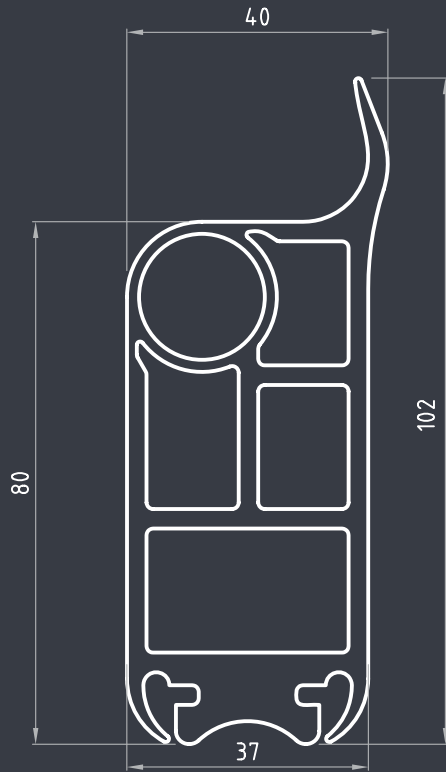

Part No. D00951

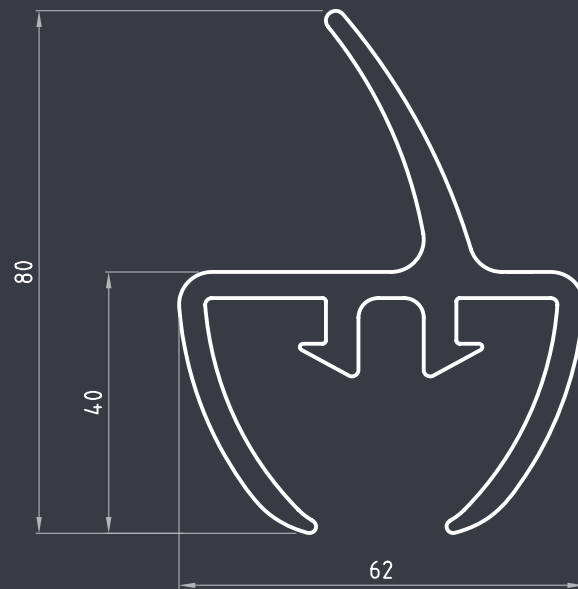

Part No. D02608

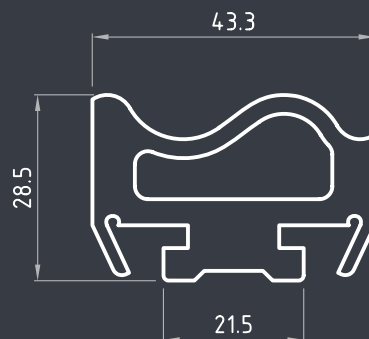

Part No. D02966

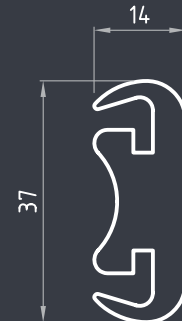

Part No. D00950

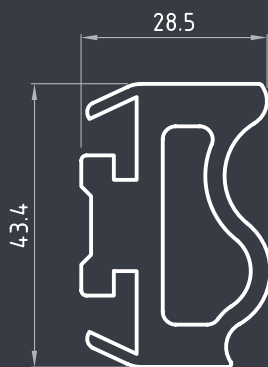

Part No. D02460

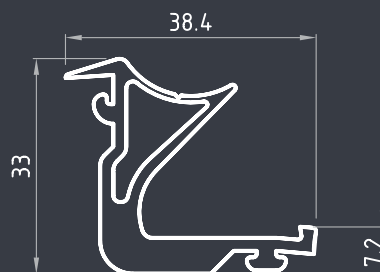

Part No. D02965

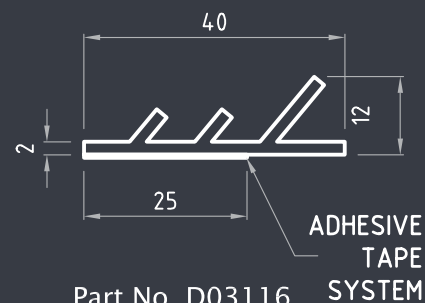

Part No. D03116

Indicative Range; Custom Design Available

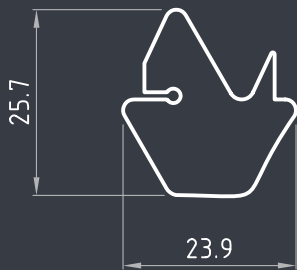

Part No. D03314

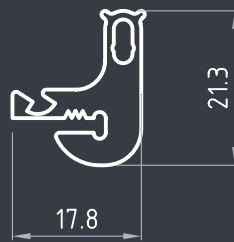

Part No. D03321

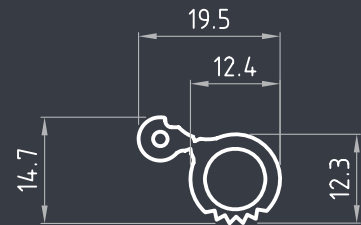

Part No. D03331

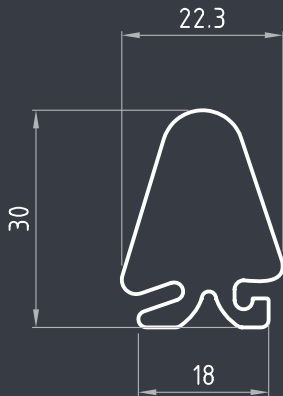

Part No. D03363

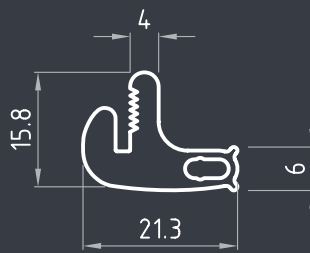

Part No. D03334

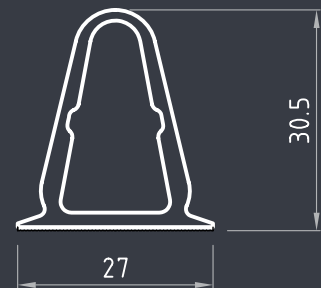

Part No. D03385

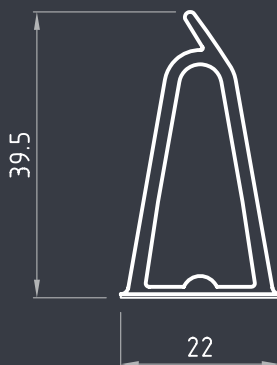

Part No. D03463

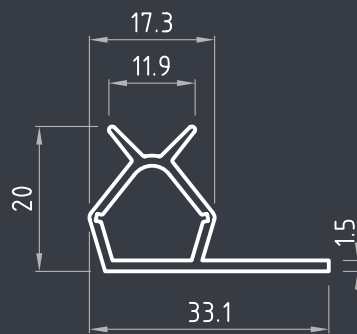

Part No. D03522

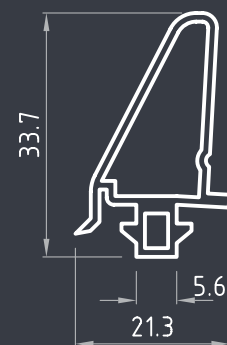

Part No. D03551

Indicative Range; Custom Design Available

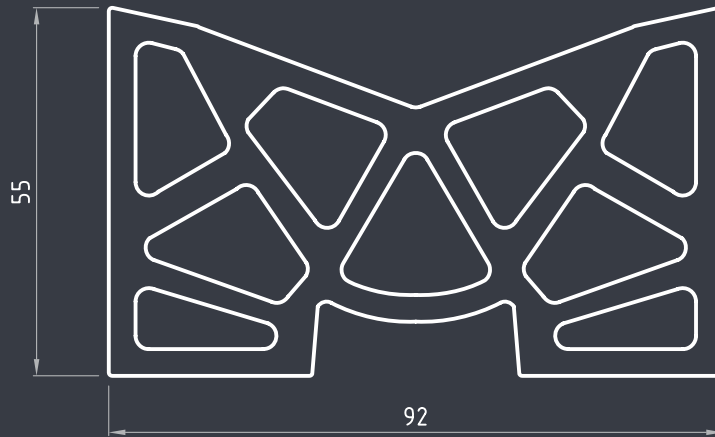

Part No. SK-2701T

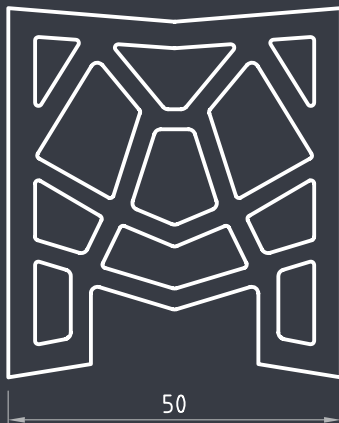

Part No. SK-2701S

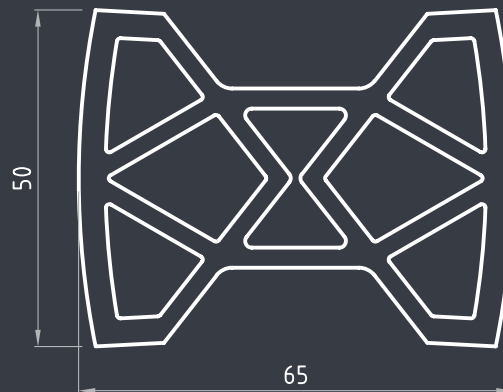

Part No. SK-2703T

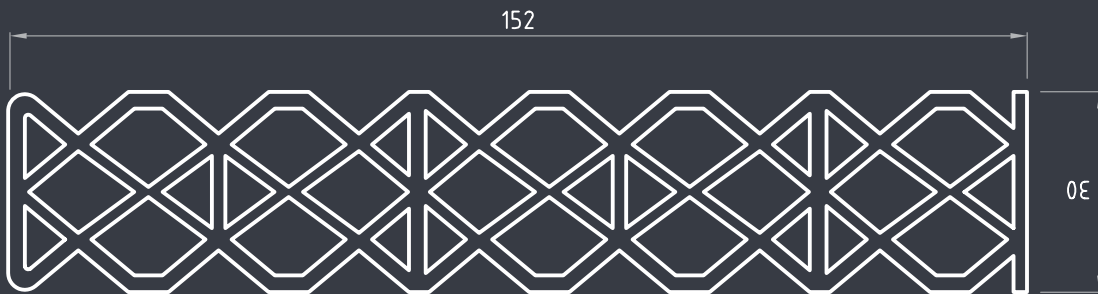

Indicative Range; Custom Design Available

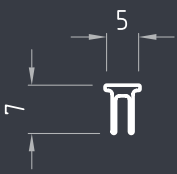

Part No. D03303

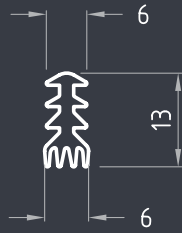

Part No. D03273

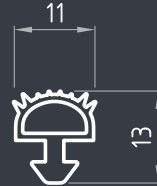

Part No. D03318

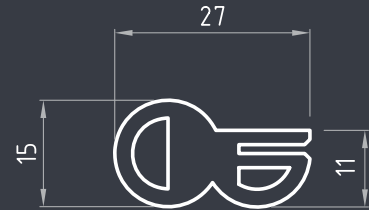

Part No. D02495

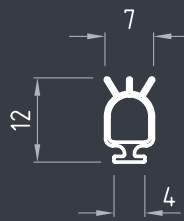

Part No. D02943

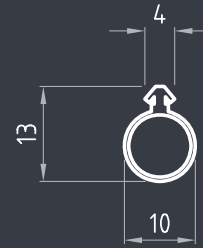

Part No. D02947

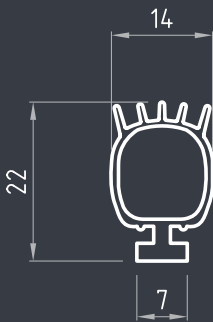

Part No. D02550

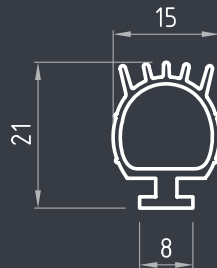

Part No. D03457

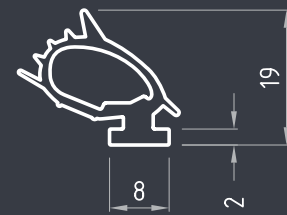

Part No. D03467

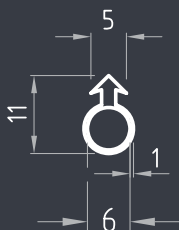

Part No. D00031

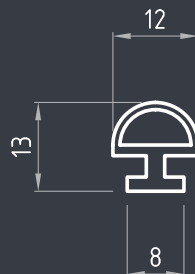

Part No. D00732

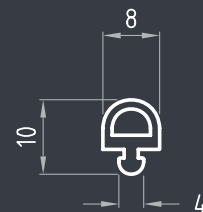

Part No. D00954

Indicative Range; Custom Design Available

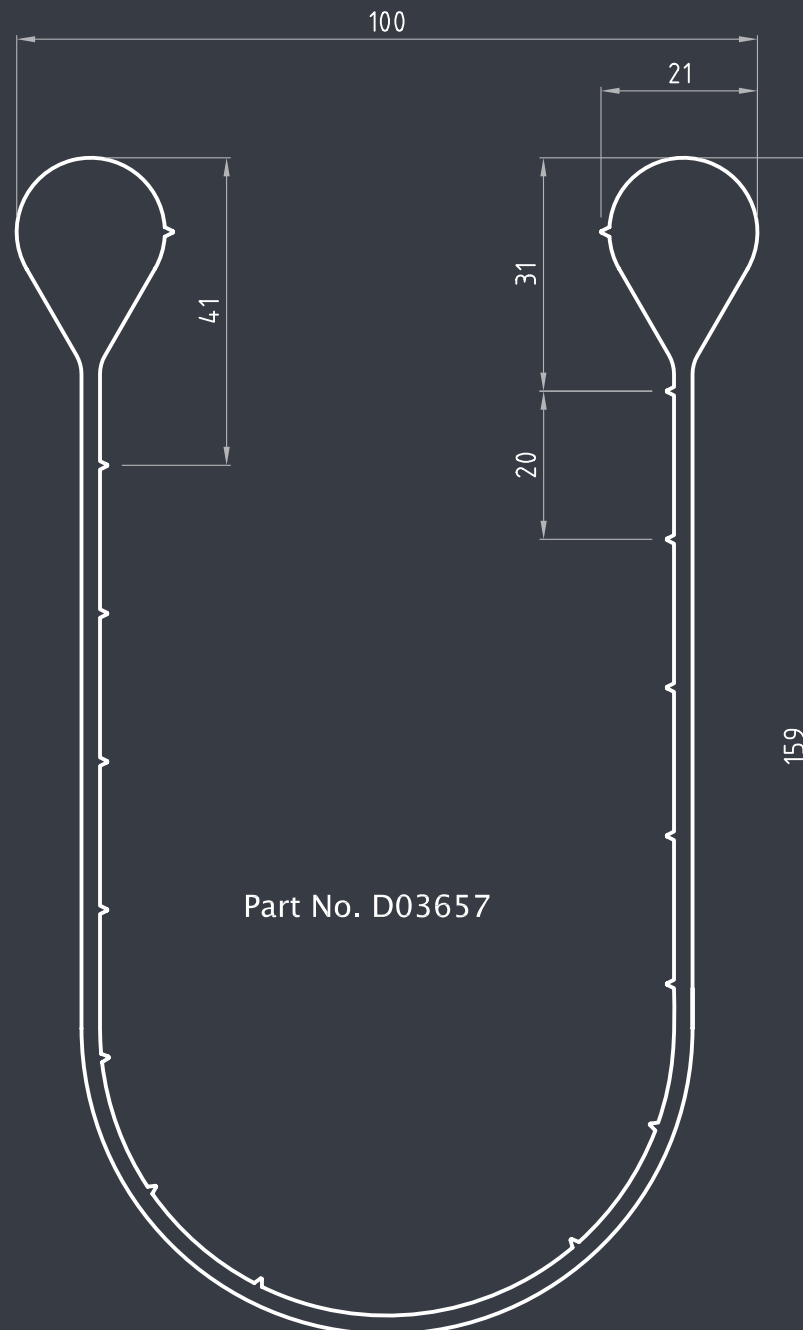

Indicative Range; Custom Design Available

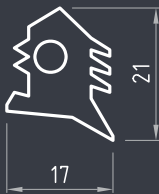

Part No. D00776



Part No. D03660

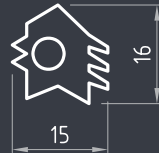

Part No. D00800



Part No. D00800



Part No. D00800



Part No. D00891



Part No. D02689

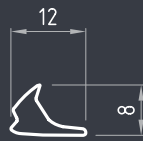

Part No. D02689-1

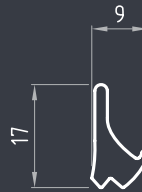

Part No. D02657

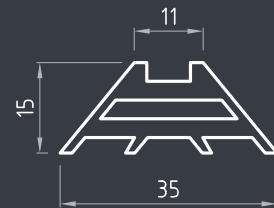

Part No. D00958

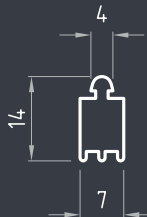

Part No. D00960



Part No. D00968



Part No. D03322

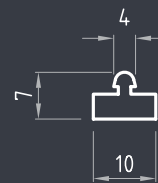

Part No. D00963



Part No. D00982

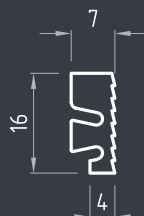

Part No. D02928

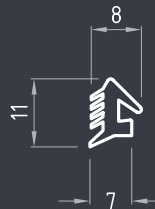

Part No. D02074

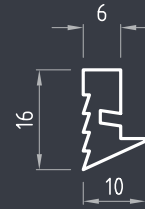

Part No. D02917

Indicative Range; Custom Design Available

Spine Seal Part No.	Total Movement (mm)	Gap Width (mm)	
		Min "A"	Max "B"
5/10	5	5	10
10/22	12	10	22
15/30	15	15	30
15/40	25	15	40
20/45	25	20	45
20/50	30	20	50
30/60	30	30	60
40/80	40	40	80

