

Indicative Range; Custom Design Available



Indicative Range; Custom Design Available



Indicative Range; Custom Design Available

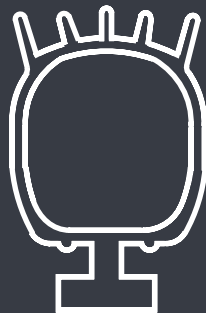
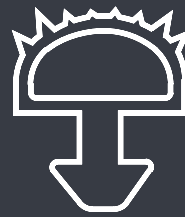
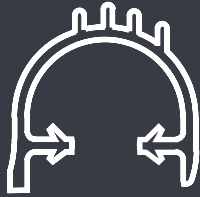

Indicative Range; Custom Design Available



Indicative Range; Custom Design Available

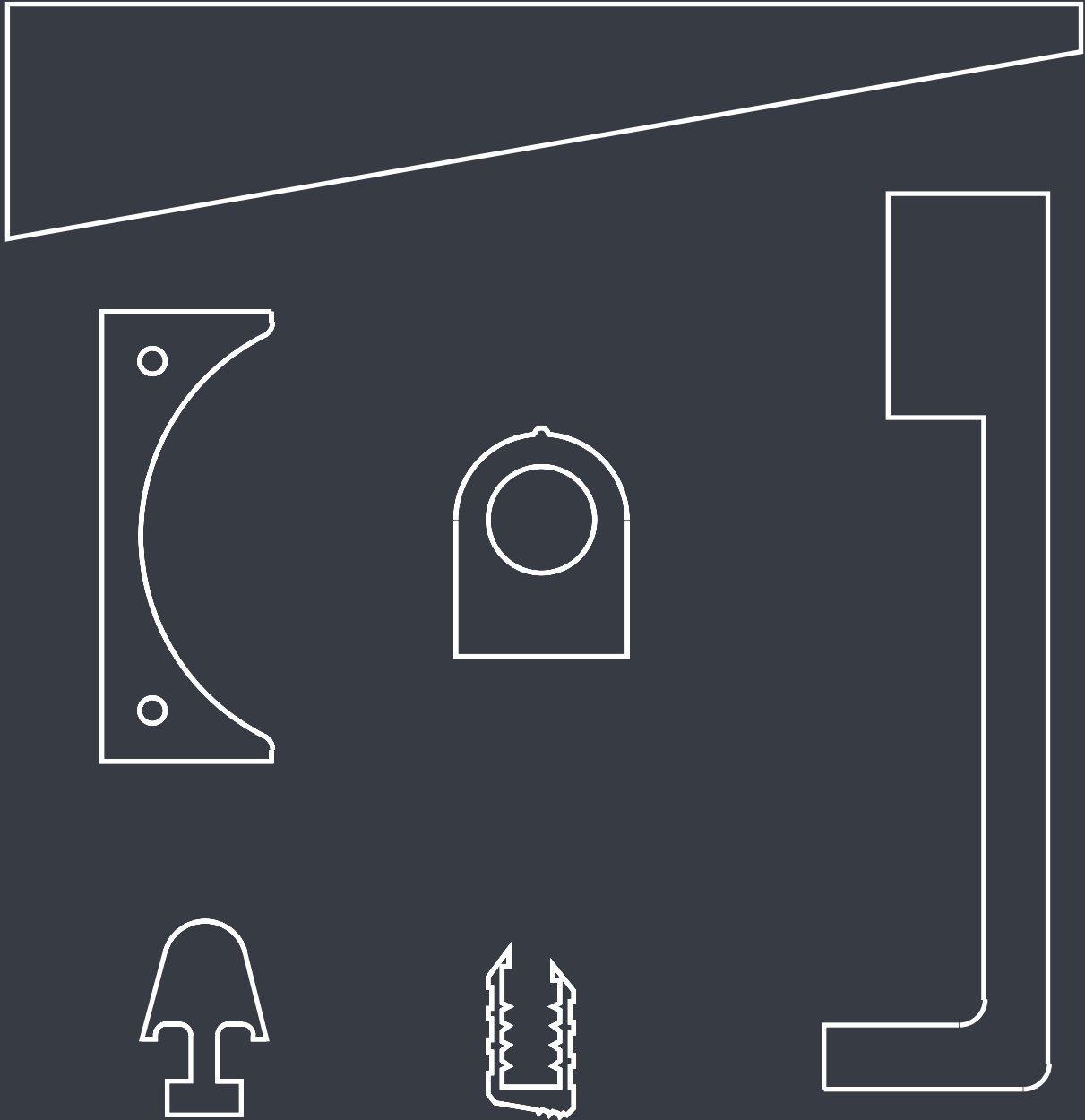

Indicative Range; Custom Design Available



Indicative Range; Custom Design Available



Indicative Range; Custom Design Available

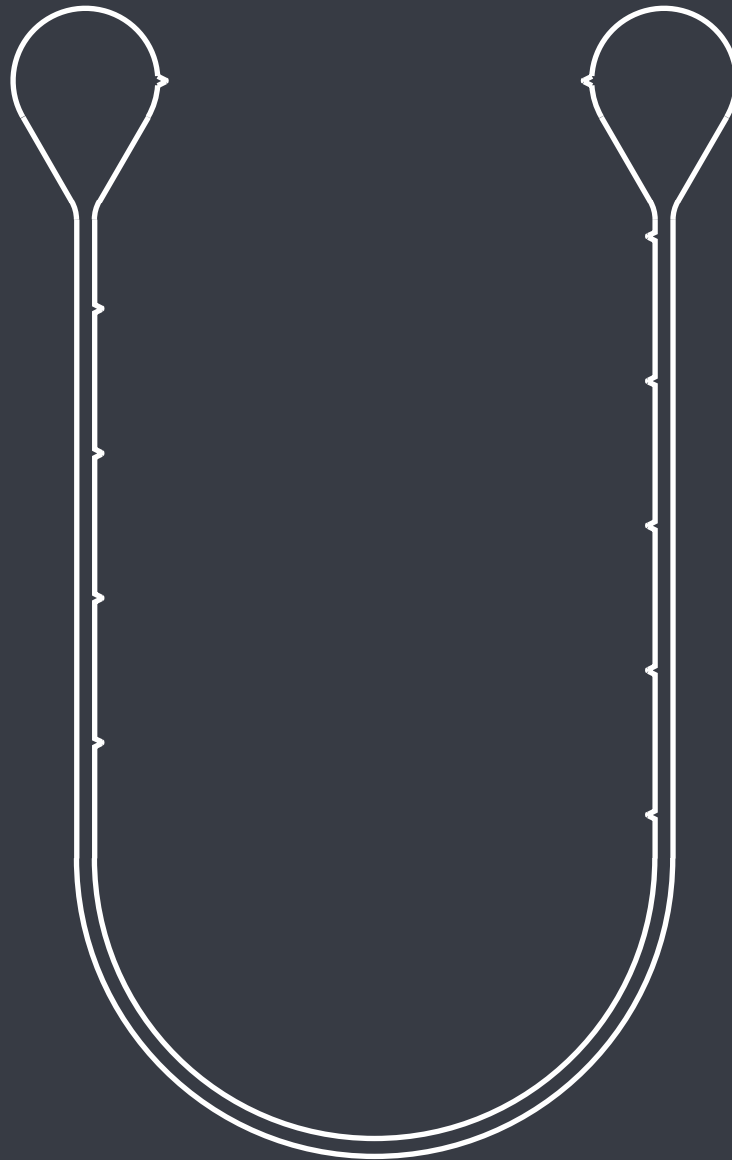



Indicative Range; Custom Design Available



Indicative Range; Custom Design Available

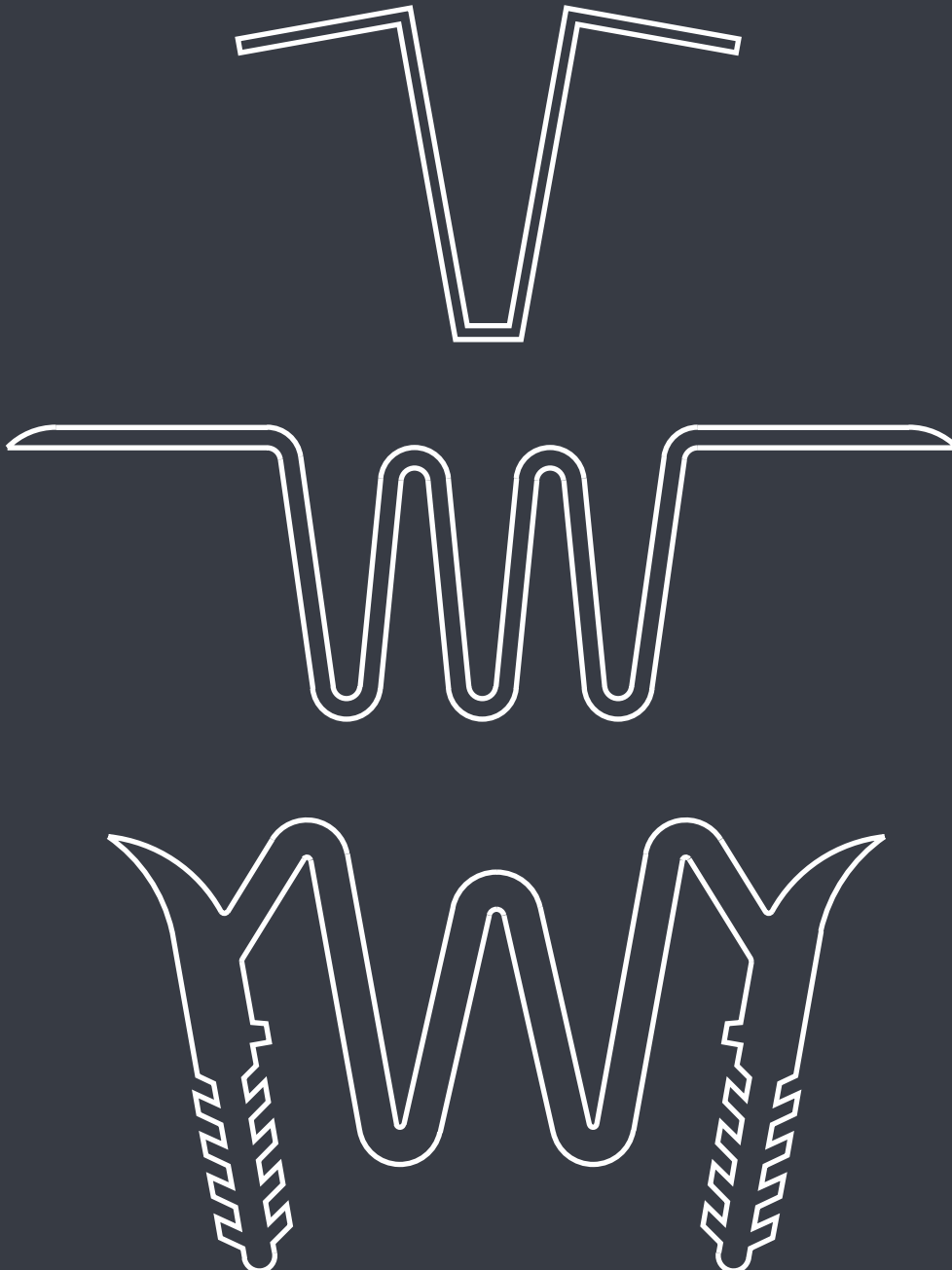

Indicative Range; Custom Design Available



Indicative Range; Custom Design Available



Indicative Range; Custom Design Available

Spine Seal Part No.	Total Movement (mm)	Gap Width (mm)	
		Min "A"	Max "B"
5/10	5	5	10
10/22	12	10	22
15/30	15	15	30
15/40	25	15	40
20/45	25	20	45
20/50	30	20	50
30/60	30	30	60
40/80	40	40	80

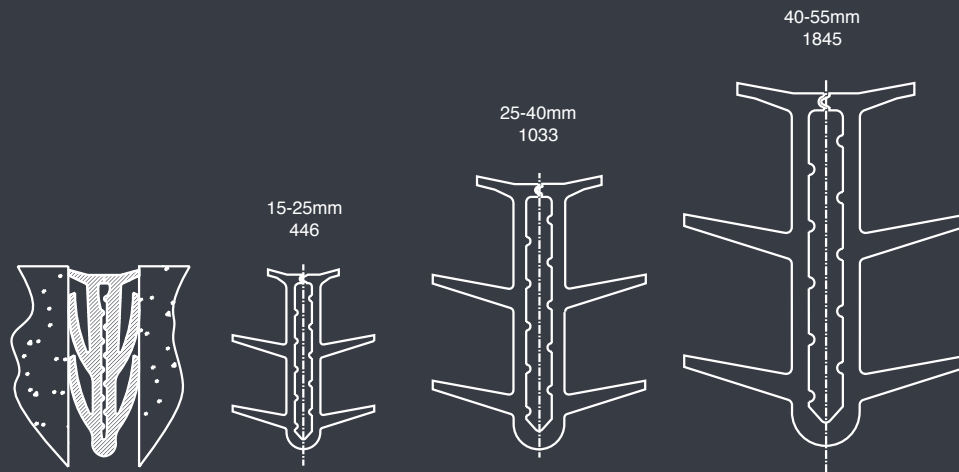

Indicative Range; Custom Design Available



Indicative Range; Custom Design Available

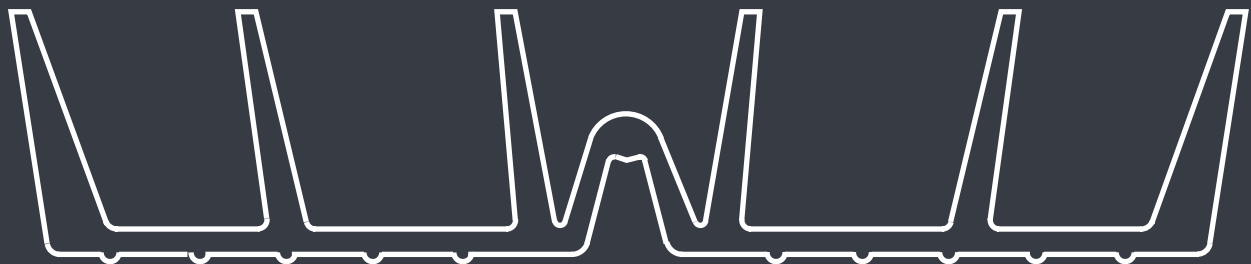
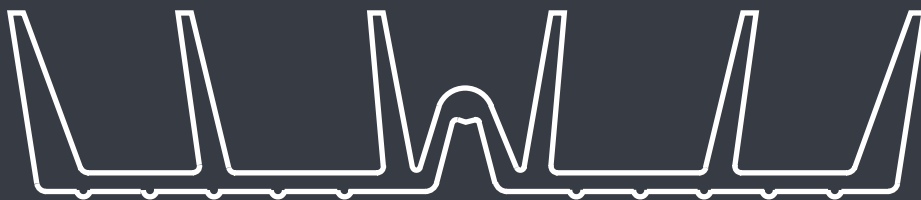

Indicative Range; Custom Design Available

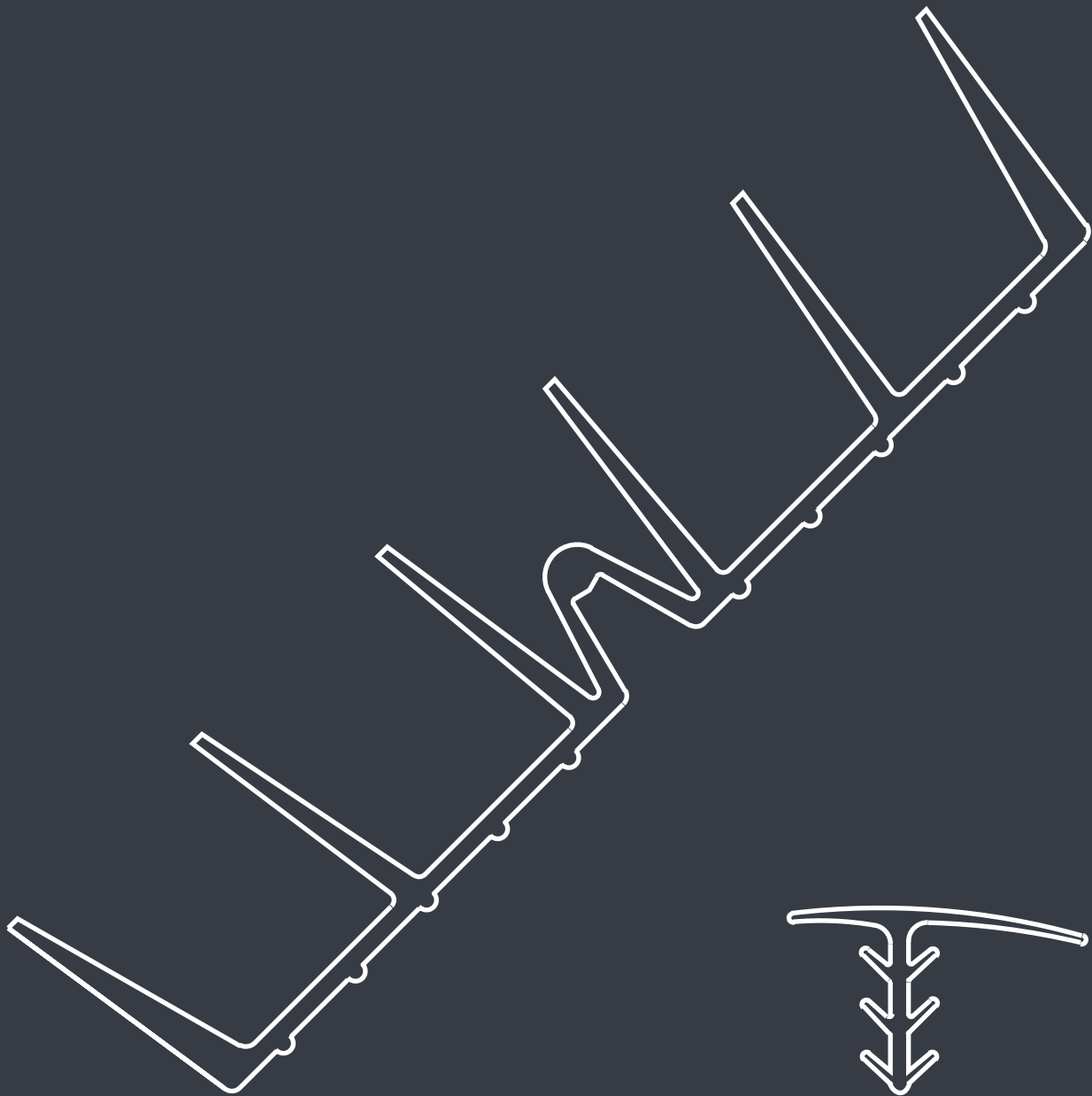



Indicative Range; Custom Design Available

