

Part No. D00994

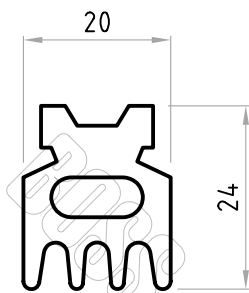

Part No. D02407

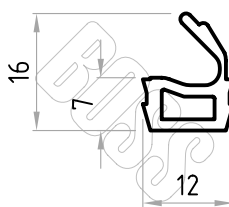

Part No. D01045

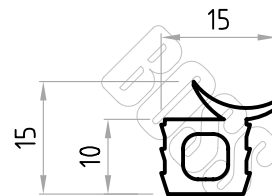

Part No. D00769

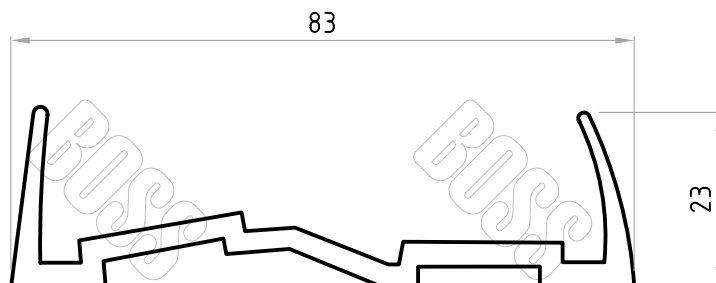

Part No. D03408

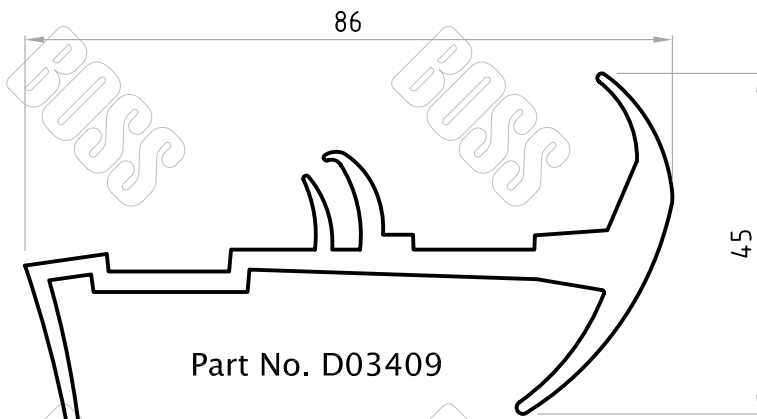

Part No. D03409

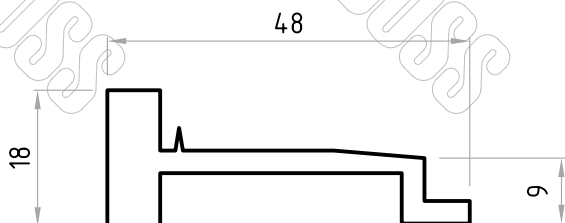

Part No. D02698

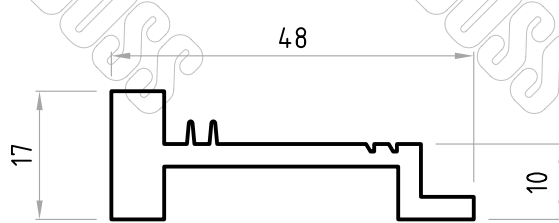

Part No. D02631

* Profile drawings appearing in this section are indicative only. some profiles may be restricted to specific customers, patents and or other limitations. The material displayed on this page may not be reprinted or otherwise reproduced without the express written permission of Boss Polymer Technologies.

BOSS POLYMER TECHNOLOGIES PTY LTD
Melbourne Australia
PH: (613) 9561 2777
FAX: (613) 9560 8777
www.bosspolymer.com.au
E-MAIL: sales@bosspolymer.com.au